

IMPORTANT MANUAL

Do Not Throw Away

WEED EATER

TRADEMARK®

OPERATOR'S MANUAL:

▲ WARNING: Read the Operator's Manual and Follow All Warnings and Safety Instructions. Failure To Do So Can Result in Serious Injury.

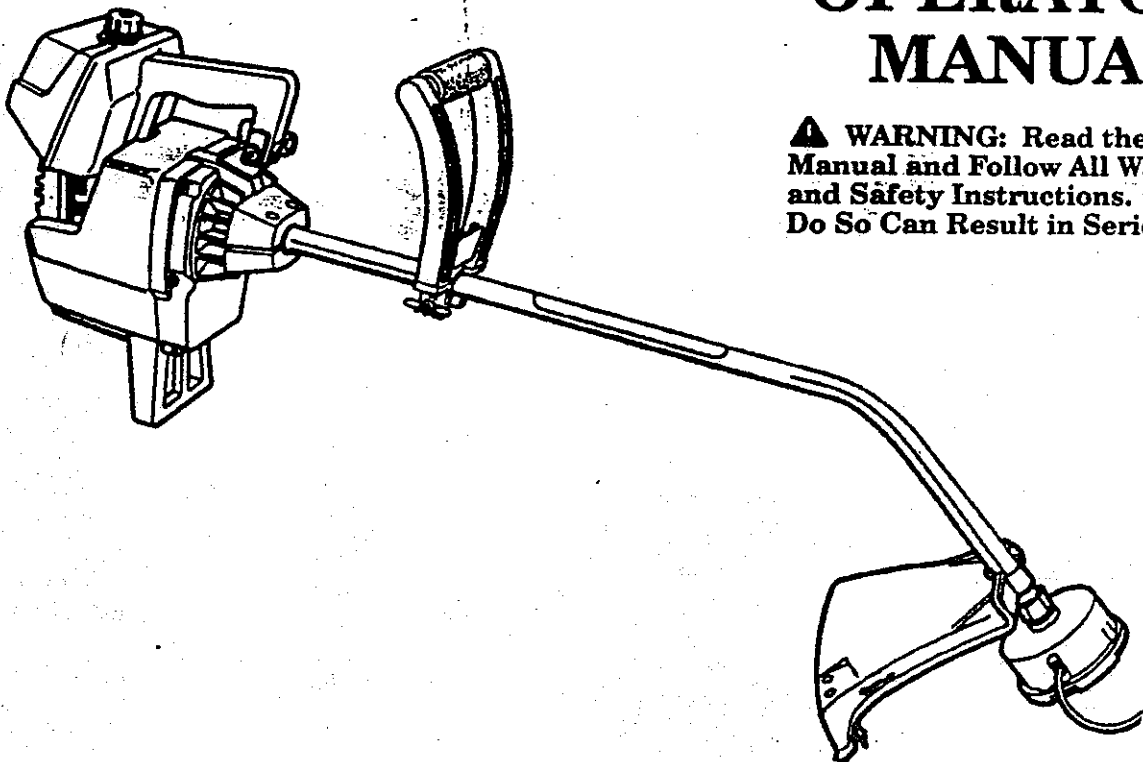

Always Wear Eye Protection During Operation

MODEL: GTI™ 16 SUPER
GAS POWERED TRIMMER (17")

TABLE OF CONTENTS

<p>WARNINGS AND SAFETY INSTRUCTIONS ... 3</p> <p>KNOW YOUR UNIT 5</p> <p>ASSEMBLY 6</p> <p>ACCESSORIES 8</p> <p>ENGINE INFORMATION</p> <p style="padding-left: 20px;">A. Fueling Your Engine 9</p> <p style="padding-left: 20px;">B. Pre-Operation Checks 9</p> <p style="padding-left: 20px;">C. Starting Instructions 10</p> <p style="padding-left: 20px;">D. Operating Instructions 10</p> <p>USING YOUR TRIMMER</p> <p style="padding-left: 20px;">A. Line Trimmer Safety 11</p>	<p style="padding-left: 20px;">B. Trimmer Line Advance 12</p> <p style="padding-left: 20px;">C. Cutting Methods 12</p> <p style="padding-left: 20px;">D. Line Replacement 12</p> <p>GENERAL MAINTENANCE</p> <p style="padding-left: 20px;">A. Maintenance Safety 15</p> <p style="padding-left: 20px;">B. Starter Rope 15</p> <p style="padding-left: 20px;">C. Carburetor Adjustments 16</p> <p style="padding-left: 20px;">D. Air Filter 17</p> <p style="padding-left: 20px;">E. Drive Shaft Lubrication 18</p> <p style="padding-left: 20px;">F. Trouble Shooting Chart 19</p>
---	--

SPECIFICATIONS

ENGINE TYPE:	2-Cycle, Air Cooled
DISPLACEMENT:	30cc
ENGINE RPM:	Operating—7500 Idle—3400-4000
IGNITION:	Solid State
CARBURETOR:	Diaphragm All Position With Adjustable Fuel Mixture Jet
ENGINE "OFF":	Positive Switch
STARTER:	Auto Rewind
MUFFLER:	Temperature Limiting (not spark arresting)
CUTTING PATH:	17"
FUEL TANK:	400cc
SPARK PLUG:	Champion (CJ-14)
SPARK PLUG GAP:	.025"
MODULE AIR GAP:	.010" to .014"
LUBRICATION:	Gasoline/Oil Mixture - 40:1 (see "Fueling Your Engine")
CUTTING LINE:	.080" Diameter WEED LINE® Brand Line

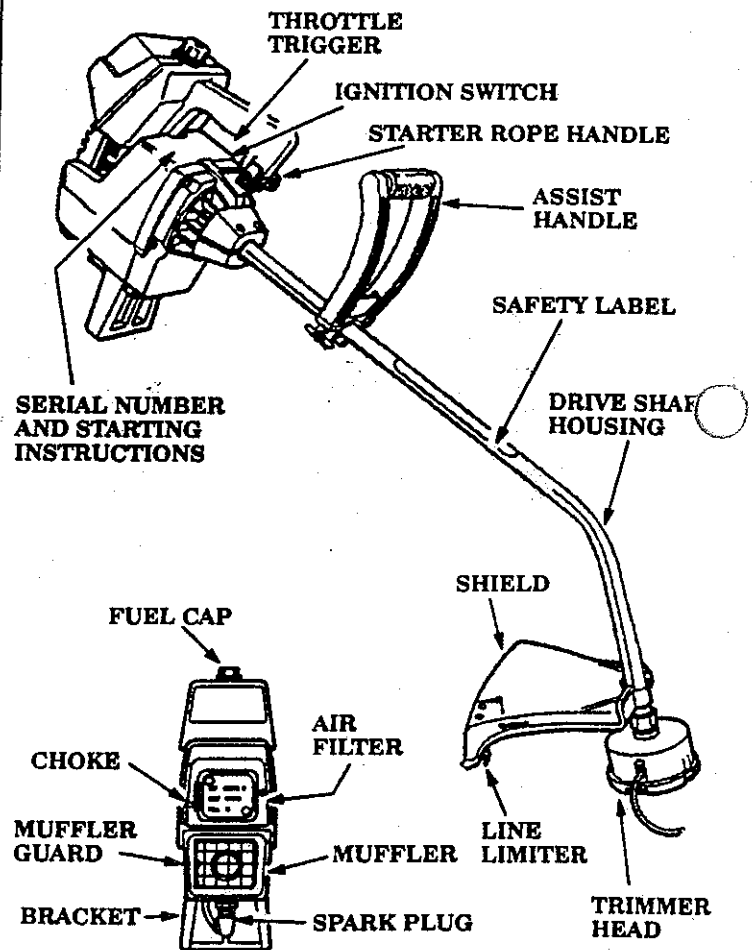

MANUFACTURED UNDER ONE OR MORE OF THE FOLLOWING U.S. PATENTS: 3,826,068; 3,859,776; 4,035,912; 4,052,789; 4,054,992; 4,067,108; 4,104,797; 4,107,901; 4,112,653; 4,114,269; 4,124,938; 4,136,446; 4,156,312; 4,156,967; 4,161,820; 4,167,812; 4,168,572; 4, 183,138; 4,189,833; 4,211,004; 4,211,005; 4,236,311; 4,236,312; 4,269,372; 4,286,675; 4,290,200; 4,362,074; 4,366,622; 4,382,356; 4,451,983; 4,483,069; 4,798,185; 4,819,742; 4,823,465; 4,825,548; 4,835,867; 4,841,929; 4,846,123. OTHER U.S. AND FOREIGN PATENTS PENDING.

SPECIAL NOTICE

For users on U.S. Forest Land and in some states, including California (Public Resources Codes 4442 and 4443), Idaho, Maine, Minnesota, New Jersey, Oregon, and Washington: Certain internal combustion engines operated on forest, brush, and/or grass-covered land in the above areas are required to be equipped with a spark arrester maintained in effective working order, or the engine must be constructed, equipped, and maintained for the prevention of fire. Check with your state or local authorities for regulations pertaining to these requirements. Failure to follow these requirements is a violation of the law. **This unit is not factory-equipped with a spark arrester;** however, a spark arrester is available as an optional part. If a spark arrester is required in your area, contact your Authorized Service Dealer for the correct kit.

▲ WARNINGS AND SAFETY INSTRUCTIONS

(See Additional Safety Instructions throughout this Manual)

▲ WARNING – THIS POWER TOOL CAN BE DANGEROUS! This tool can cause serious injury or blindness to the operator and others. The warnings and safety instructions in this manual must be followed to provide reasonable safety and efficiency in using this tool. The operator is responsible for following the warnings and instructions in this manual and on the tool. **Read the entire Operator's Manual before assembling and using this tool!** Restrict the use of this power tool to persons who read, understand and follow the warnings and instructions in this manual and on the tool.



▲ DANGER

NEVER USE BLADES WITH THIS TOOL.

- THE BLADE CAN COME OFF AND SERIOUSLY HURT YOU AND OTHERS.
- THIS TOOL IS DESIGNED FOR LINE TRIMMER USE ONLY

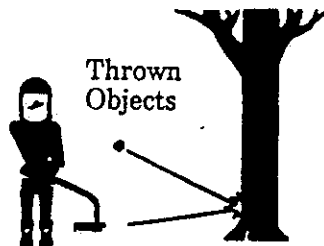
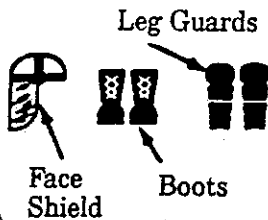

▲ WARNING

TRIMMER LINE CAN THROW OBJECTS VIOLENTLY.

- YOU CAN BE BLINDED OR INJURED.
- WEAR EYE AND LEG PROTECTION.

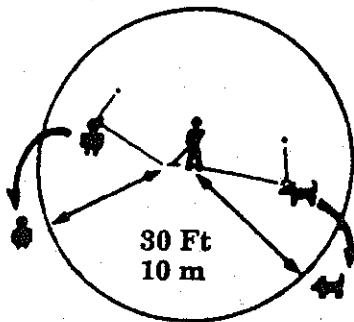

60 Foot
(20 meters)
Hazard Zone

▲ WARNING

HAZARD ZONE FOR THROWN OBJECTS

- TRIMMER LINE CAN THROW OBJECTS VIOLENTLY.
- OTHERS CAN BE BLINDED OR INJURED.
- KEEP PEOPLE AND ANIMALS 30 FEET (10 METERS) AWAY.



Operator's
Manual



Safety
Labels

▲ WARNING

READ OPERATOR'S MANUAL.

- FOLLOW ALL WARNINGS AND INSTRUCTIONS.
- FAILURE TO DO SO CAN RESULT IN SERIOUS INJURY.

WARNINGS AND SAFETY INSTRUCTIONS....(Continued)

▲ OPERATOR SAFETY

1. Always wear a safety face shield or safety goggles. See "Accessories."
2. Always wear heavy, long pants, boots and gloves. Wearing safety leg guards is recommended. See "Accessories." Do not wear loose clothing, jewelry, short pants, sandals or go barefoot. Secure hair so it is above shoulder length. Being fully covered will help protect you from pieces of toxic plants such as poison ivy thrown by the trimmer head which could be more of a hazard than touching the plant itself.
3. Do not operate this tool when you are tired, ill or under the influence of alcohol, drugs or medication.
4. Wear hearing protection if you use this tool for more than 1 1/2 hours per day.
5. Never start or run the engine inside a closed room or building. Breathing exhaust fumes can kill.
6. Keep handles free of oil and fuel.

▲ TOOL SAFETY

7. Inspect entire tool before each use. Replace damaged parts. Check for fuel leaks. Make sure all fasteners are in place and securely fastened.
8. Replace trimmer head parts that are cracked, chipped, or damaged before using the tool.
9. Use only .080" diameter WEED LINE® brand line. Never use wire, rope, string etc.
10. Install the shield properly before using the tool.
11. Use only the specified trimmer head. Make sure the trimmer head is properly installed and securely fastened. Refer to "Assembly."
12. Make carburetor adjustments with the drive shaft housing supported to prevent the trimmer line from contacting any object. Hold the tool by hand; do not use the shoulder strap for support.
13. Keep others away when making carburetor adjustments.
14. Use only genuine WEED EATER® accessories as recommended for this tool.

▲ FUEL SAFETY

15. Mix and pour fuel outdoors and where there are no sparks or flames.
16. Use a container approved for fuel.
17. Do not smoke or allow smoking near fuel or the tool or while using the tool.
18. Wipe up all fuel spills before starting engine.
19. Move at least 10 feet (3 meters) away from fueling site before starting engine.
20. Stop engine before removing fuel cap.
21. Empty the fuel tank before storing the tool. Use up fuel left in the carburetor by starting the engine and letting the engine run until it stops.
22. Store tool and fuel in an area where fuel vapors cannot reach sparks or open flames from water heaters, electric motors or switches, furnaces, etc.

▲ CUTTING SAFETY

23. Inspect the area to be cut before each use. Remove objects (rocks, broken glass, nails, wire, string, etc.) which can be thrown or become entangled in the trimmer head.
24. Keep others including children, animals, bystanders and helpers outside the 60 foot (20 meter) Hazard Zone. Stop the engine immediately if you are approached.
25. Always keep the engine on the right-hand side of your body.
26. Hold the tool firmly with both hands.
27. Keep firm footing and balance. Do not over-reach.
28. Keep the trimmer head below waist level.
29. Do not raise the engine above your waist. The trimmer head can come dangerously close to your body.
30. Keep all parts of your body away from trimmer head and muffler when engine is running.
31. Cut from your left to your right.
32. Use only for jobs explained in this manual.

▲ MAINTENANCE SAFETY

33. Maintain the tool according to recommended procedures. Keep the cutting line at the proper length.
34. Disconnect the spark plug before performing maintenance except for carburetor adjustments.
35. Make carburetor adjustments with the drive shaft housing supported to prevent the trimmer line from contacting any object. Hold the tool by hand; do not use the shoulder strap for support.
36. Keep others away when making carburetor adjustments.
37. Use only genuine WEED EATER replacement parts as recommended.

▲ TRANSPORTING AND STORAGE

38. Hand carry the tool with the engine stopped and the muffler away from your body.
39. Allow the engine to cool, empty the fuel tank, and secure the tool before storing or transporting in a vehicle.
40. Empty the fuel tank before storing the tool. Use up fuel left in the carburetor by starting the engine and letting the engine run until it stops.
41. Store tool and fuel in an area where fuel vapors cannot reach sparks or open flames from water heaters, electric motors or switches, furnaces, etc.
42. Store tool so line limiter cannot accidentally cause injury. The tool can be hung by the bracket below the engine or by drive shaft housing.
43. Store the tool out of the reach of children.

If situations occur which are not covered in this manual, use care and good judgment. Contact your Authorized Service Dealer if you need assistance.

KNOW YOUR UNIT

A. INTRODUCTION

Your Trimmer is a versatile product developed for large lawns and to make short work of a variety of lawn care tasks — trimming, scalping, mowing, and sweeping.

Special Features Include:

- ComforTouch® Anti-vibration Handle
- All-Position Carburetor
- Adjustable Cushioned Assist Handle
- SensorFeed™ Automatic Cutting Head
- 17" Cutting Path

B. UNPACKING INSTRUCTIONS

1. After removing the contents from the carton, check parts against the Carton Contents list.
2. Examine the parts for damage. Do not use damaged parts.
3. Notify your **WEED EATER** dealer immediately if a part is missing or damaged.

NOTE: It is normal to hear the fuel filter rattle in an empty fuel tank.

C. CARTON CONTENTS

KEY NO.		QTY
1.	Engine	1
2.	Drive Shaft Assembly w/Safety Label	1
3.	Shield	1
4.	Trimmer Head	1
5.	Assist Handle	1
—	Operator's Manual (not shown)	1
—	Loose Parts Bag (not shown)	1

LOOSE PARTS BAG CONTENTS:

6.	Shield Bracket	1
7.	Dust Cup - Drive Shaft Housing	1
8.	5/32 inch Hex Wrench	1
A.	Hex Socket Screw - Front Shroud	2
B.	Screw - Shield	2
C.	Hex Head Screw - Assist Handle	1
D.	Wing Nut - Assist Handle	1
E.	Lock Nut - Front Shroud	2
F.	Flat Washer - Assist Handle	1

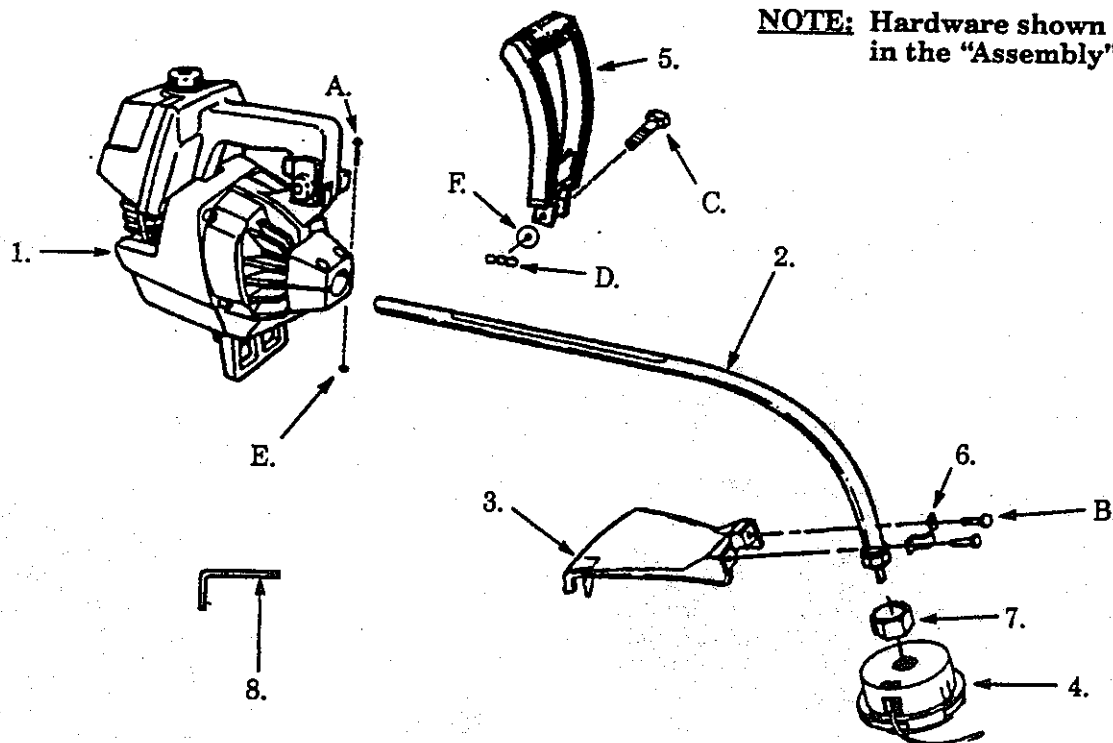

NOTE: Hardware shown actual size in the "Assembly" section.

SAFETY NOTICE

Exposure to vibrations through prolonged use of gasoline powered hand tools could cause blood vessel or nerve damage in the fingers, hands, and wrists of people prone to circulation disorders or abnormal swellings. Prolonged use in cold weather has been linked to blood vessel damage in otherwise healthy people. If symptoms occur such as numbness, pain, loss of strength, change in skin color or texture, or loss of feeling in the fingers, hands or wrists, discontinue the use of this tool and seek medical attention. An anti-vibration system does not guarantee the avoidance of these problems. Users who operate power tools on a continual and regular basis must monitor closely their physical condition and the condition of this tool.

ASSEMBLY

(If tool is received assembled, repeat all steps in this section to be sure assembly is correct and is adjusted for the operator.)

A. PREPARATION

This Operator's Manual is designed to help you assemble the tool and to provide its safe operation. It is important that you read the entire manual to become familiar with the tool *before* you begin assembly.

1. Read your Operator's Manual

2. Tools you will need:

- 5/32" Hex Wrench provided with the tool.
- Adjustable Wrench
- Standard Screwdriver

B. HARDWARE USAGE

Refer to the Hardware reference letters below during assembly.
NOTE: This Hardware is packaged in the Plastic Bag.

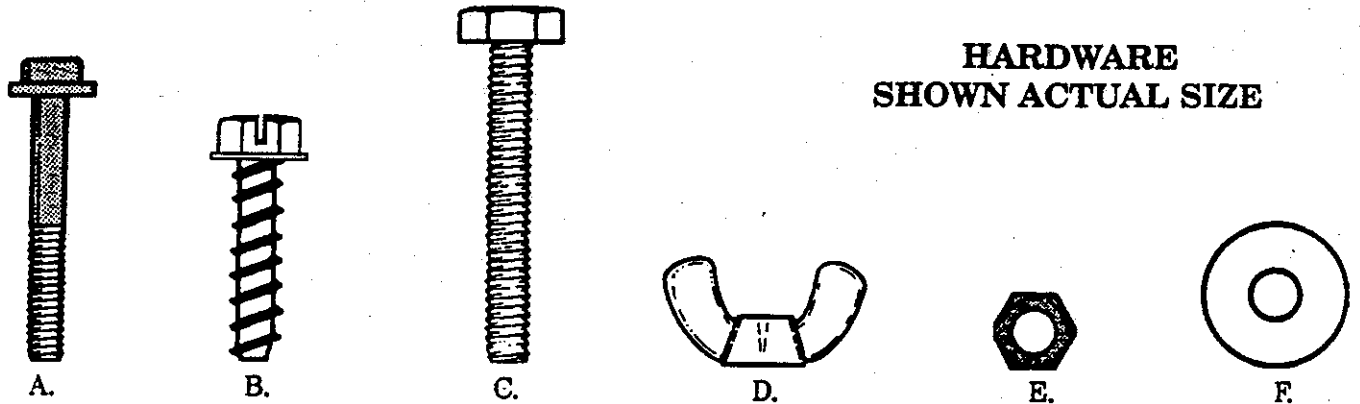

**HARDWARE
SHOWN ACTUAL SIZE**

Figure 1

C. ASSEMBLY STEPS

1. DRIVE SHAFT HOUSING (Figure 2)

- a. Place the two Screws "A." into the holes on the Front Shroud as shown in Figure 2.
- b. Position the Lock-Nuts "E." in the hex openings in the Front Shroud.
- c. Tighten the Screws with the hex wrench (provided) just enough to hold the hardware together while holding the Lock-Nuts with your other hand.
- d. Remove the packing cover from the straight end of the Drive Shaft Housing.

NOTE: Make sure the Flexible Drive Shaft does not fall out of the Drive Shaft Housing. Dirt on the Shaft will significantly reduce the life of the tool. If the Flexible Drive Shaft falls out of the Housing, clean, re-lubricate, and re-install. See "Flexible Drive Shaft Lubrication" in the Maintenance section.

- e. Align the bottom groove on the Drive Shaft Housing with the ridge on the inner, lower wall of the Front Shroud opening.
- f. Turn the Arbor Shaft as necessary to align the square end of the Flexible Drive Shaft with the square hole inside the Front Shroud opening. Figure 2 (inset).
- g. Firmly push the Drive Shaft Housing into the Front Shroud opening until the Depth Groove is no longer visible (about 1-1/2 inches).
- h. Tighten Screws "A." alternately with the hex wrench until secure. Figure 2.

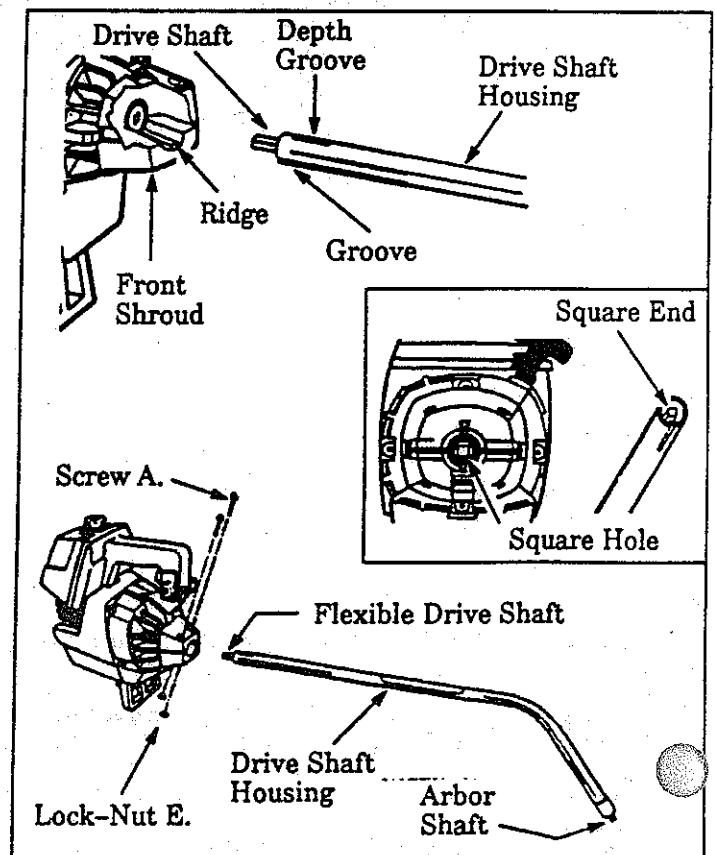

Figure 2

2. ASSIST HANDLE

- Align the Assist Handle above the Safety Label and below the Engine. Figure 3.
- Firmly push Assist Handle over Drive Shaft Housing while supporting Drive Shaft Housing.
- Insert the Assist Handle Screw "C." through the new hole in the Assist Handle. Figure 3.
- Place Washer "F." over the threaded end of the Assist Handle Screw. Thread Wing Nut "D." onto Assist Handle Screw. Tighten securely.

CAUTION: When adjusting the Assist Handle for comfort, be sure that the Assist Handle remains between the Engine and the Safety Label on Drive Shaft Housing. Figure 3.

- Adjust Assist Handle up or down the Shaft Housing for comfort. Figure 3 (inset).

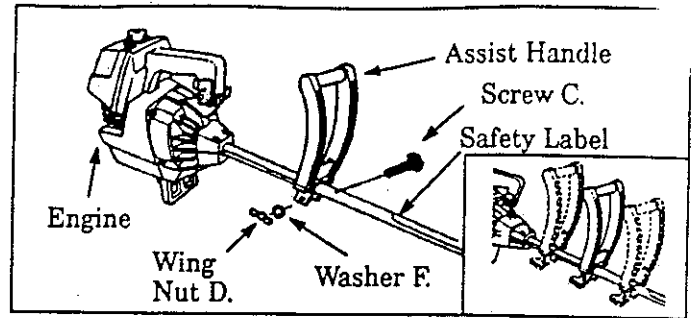

Figure 3

3. TRIMMER HEAD

- Place the Dust Cup on the Drive Shaft Housing over the hex nut that is assembled on the arbor Shaft. Figure 4.
- Hold the Dust Cup with a wrench to keep the Arbor Shaft from turning.
- Thread the Trimmer Head onto the Arbor Shaft against Dust Cup and tighten firmly. Figure 4.

NOTE: Unless Trimmer Head is tightened adequately, it can unthread when engine is started or stopped. If this situation occurs, reinstall Trimmer Head and tighten more securely.

NOTE: To remove Trimmer Head, hold Dust Cup with a wrench and unthread Trimmer Head.

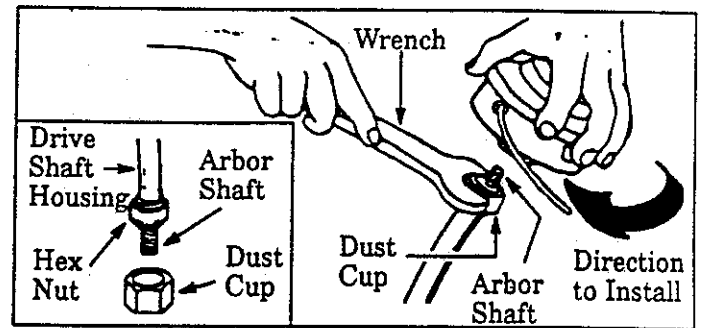

Figure 4

4. SHIELD ATTACHMENT

▲ WARNING

The shield must be properly installed. The shield provides partial protection from the risk of thrown objects to the operator and others and is equipped with a line limiter which cuts excess line to the proper length.

▲ WARNING

Do not alter or remove the Bracket Tab. When installed correctly, the Bracket Tab ensures proper shield orientation. Failure to install the shield in the position shown in Figure 5 can result in serious injury to the operator. The length of the shield must be aligned with the length of the drive shaft housing. Direct the widest part of shield toward engine. Figure 5.

CAUTION: The line limiter (on the underside of the shield) is sharp and can cut you.

- Match the Tab on the Bracket with the hole on the Drive Shaft Housing. Figure 5.

- Attach the Shield to the Bracket with the two Screws "B." as Shown in Figure 5.

NOTE: It is easier to start the Screws with a screwdriver and finish tightening with a wrench.

- Tighten the Screws evenly and securely.

NOTE: It is possible that a small space will be left between the Bracket and the Shield when the screws are fully tightened.

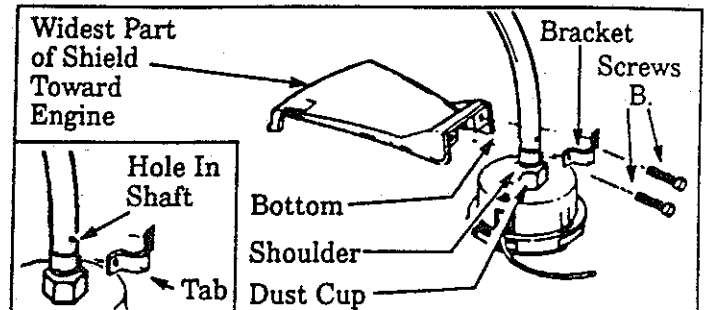

Figure 5

5. OPERATING POSITION

- a. Before starting the engine, stand as shown in Figure 6 and check for the following:
 1. Left arm fully extended, hand holding Assist Handle.
 2. Right arm slightly bent, hand holding Top Handle, fingers on Throttle Trigger.
 3. Top Handle below waist level.
 4. Weight of tool evenly distributed between arms.
 5. Without operator bending over, the Trimmer Head is near and parallel to the ground and easily contacts the material to be cut.
- b. Adjust the Assist Handle up or down the Drive Shaft Housing (*but above the safety labels*) to a comfortable position.
 1. Loosen Wing Nut by hand and adjust Assist Handle. Retighten Wing Nut by hand *only*.
 2. Rotate Assist Handle from left to right to tilt the angle of the Trimmer Head when cutting a large, sloped area such as a ditch bank.

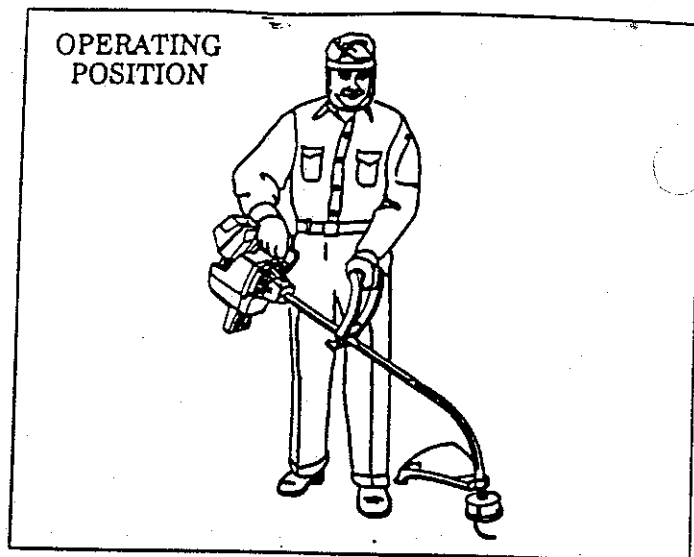

Figure 6

WEED EATER® ACCESSORIES

ITEM	STOCK NO.
SAFETY FACE SHIELD	952-701601
SAFETY GOGGLES	952-701506
SAFETY LEG GUARDS	952-701600
WEED EATER® 40:1 2-CYCLE ENGINE OIL	
—3.2 oz.	952-030133
—8 oz.	952-030128
FUEL CAP	952-701583
SensorFeed™ TRIMMER HEAD	952-701605
SPOOL W/LINE	952-710607
NYLON CUTTING LINE	
80 Ft. (.080 Dia.) Cutting Line	952-701534
200 Ft. (.080 Dia.) Cutting Line	952-701595
400 Ft. (.080 Dia.) Cutting Line	952-701590
FLEX SHAFT LUBE	952-701570
AIR FILTER	952-701614
SPARK PLUG	530-030077
OPERATOR'S MANUAL	530-067712
ILLUSTRATED PARTS LIST	530-067702

NOTES

ENGINE INFORMATION

A. FUELING YOUR ENGINE

1. FUEL SAFETY

- a. Use only recommended fuel mixtures.
- b. Mix and pour fuel outdoors and where there are no sparks or flames.
- c. Use a container approved for fuel.
- d. Do not smoke or allow smoking near fuel or the tool or while using the tool.
- e. Wipe up all fuel spills before starting the engine.
- f. Move at least 10 feet (3 meters) away from fueling site before starting engine.
- g. Stop engine before removing fuel cap.
- h. Empty fuel tank before storing tool. Use up fuel left in carburetor by starting engine and letting engine run until it stops.
- i. Store tool and fuel in an area where fuel vapors cannot reach sparks or open flames from water heaters, electric motors or switches, furnaces, etc.

2. FUEL MIXTURE

- a. Your tool is powered by a 2-cycle engine which requires a fuel mixture of regular unleaded gasoline and a high quality engine oil specially made for 2-cycle, air cooled engines.

The internal design of the 2-cycle engine requires lubrication of moving parts. Lubrication is provided when the recommended mixture of gasoline and oil is used.

- b. **Genuine WEED EATER 40:1, 2-cycle engine oil is strongly recommended for the protection of your unit.** Extensive engineering tests have proven that WEED EATER oil resists break-down at operating temperatures common to 2-cycle engines, resulting in dependable performance and longer engine life.
- c. **Gasoline must be clean and not over two months old.** After a short period of time, gasoline will chemically break down and form compounds that cause hard starting and damage in 2-cycle engines.

- d. The correct measure of gasoline to very important. Too much oil in the mixture will foul the spark plug.

CAUTION: Too little oil or incorrect oil will cause the engine to overheat and seize.

- e. Always mix the fuel thoroughly in a container since gasoline and oil do not readily combine. *Do not mix gasoline and oil directly in the fuel tank.*

3. USE THE FOLLOWING:

WEED EATER 40:1 Engine Oil is strongly recommended. Any other WEED EATER or Poulan brand 2-cycle engine oil is acceptable when mixed according to the instructions on the can.

If WEED EATER or Poulan 2-cycle engine oil is not available, use a good quality, 2-cycle engine oil mixed at a ratio of 16:1 (8 oz. oil to 1 gallon gasoline).

4. DO NOT USE:

- a. **BIA OIL (Boating Institute of America)**
Does not have proper additives for air-cooled 2-cycle engines and can cause engine damage.
- b. **AUTOMOTIVE OIL**
Does not have proper additives for 2-cycle engines and can cause damage.

5. HOW TO MIX FUEL AND FILL TANK

- a. Pour 1/2 of the regular unleaded gasoline to be used into an approved, marked container. *Do not mix gasoline and oil directly in the fuel tank.*
- b. Add entire measure of engine oil.
- c. Cover container tightly and shake for one minute.
- d. Slowly remove fuel container cover.
- e. Add remainder of gasoline.
- f. Cover container tightly and shake again.
- g. Slowly remove fuel container cover.
- h. Slowly remove fuel cap. See "Specifications." for location.
- i. Fill the tank using a spout or funnel.
- j. Reinstall the fuel cap securely.

B. PRE-OPERATION CHECKS

▲ WARNING

Review all Warnings and Safety Instructions in this manual.

1. Before operating your tool, always:

- a. Inspect the entire tool before each use. Replace damaged parts. Check for fuel leaks and make sure all fasteners are in place and securely fastened.
- b. Replace trimmer head parts that are cracked, chipped, or damaged in any other way before using the tool.
- c. Use only WEED EATER .080" diameter WEED LINE brand line. Never use wire, rope, string, etc.

- d. Use only with the shield properly attached.
- e. Use only the specified trimmer head. See "Specifications." Make sure the trimmer head is properly installed and securely fastened. Refer to "Assembly."
- f. Make carburetor adjustments with the drive shaft housing supported to prevent the trimmer line from contacting any object. Hold the tool by hand; do not use shoulder strap for support.
- g. Keep others away when making carburetor adjustments.
- h. Use only genuine WEED EATER accessories or attachments recommended for this tool.
- i. Clean air filter if dirty before operating tool. Refer to "Specifications," for air filter location.

C. STARTING INSTRUCTIONS

(For location of controls, refer to "Specifications.")

1. Before starting the Engine:

- Fuel engine. Move 10 feet (3 meters) away from fueling site.
- Extend line approximately 6 inches from Trimmer Head to provide adequate load on engine. Figure 7.

▲ WARNING

The trimmer head will turn as soon as engine starts.

- Rest Engine and Shield on ground, supporting Trimmer Head off ground away from trees, bushes, onlookers, etc. Figure 7.

2. For a Cold Engine or Warm Engine after running out of fuel:

- Move ignition switch to "On." Figure 8.
- Move Choke to "Full" position. Figure 9.
- Grasp Top Handle and squeeze Throttle Trigger fully. *Keep Throttle Trigger fully squeezed until engine runs smoothly (through step "g.")*.
- Pull Starter Rope sharply until engine attempts to run, but no more than 8 pulls at full choke to avoid flooding the engine. *The "attempt to run" may be hard to hear. The operator must listen carefully.* After 8 pulls, proceed to step "e." even if the engine has not attempted to run.
- Move Choke to "Half" position. Figure 9.
- Pull the Starter Rope sharply until the engine runs, but no more than 5 pulls.

NOTE: If the engine has not started after 5 pulls, repeat steps "a." through "f."

- Allow engine to run 5 seconds, then push Choke to "Off" position. Figure 9. *Keep Throttle Trigger squeezed until engine runs smoothly.*

NOTE: If engine dies with Choke at "Off" position, repeat steps "e." through "g."

NOTE: If engine has not started, pull Starter Rope 5 more pulls. If engine still does not run, it is probably flooded. Wait a few minutes and repeat procedure with Choke at "Off" position. Figure 9.

D. OPERATING INSTRUCTIONS

1. Bring the engine to cutting speed before entering the material to be cut.

- Do not run the engine at a higher speed than necessary. The cutting line will cut efficiently when the engine is run at less than full throttle. At lower speeds, there is less engine noise and vibration. The cutting line will last longer and will be less likely to "weld" onto the spool.
- If the Trimmer Head does not turn when the engine is in operation, make sure the Drive Shaft Housing is properly seated in the Engine Shroud. Refer to "Assembly-Drive Shaft Housing."

▲ WARNING

Avoid any bodily contact with the muffler when starting a warm engine. A hot muffler can cause serious burns.

3. For a Warm Engine:

- Move ignition switch to "On" position. Figure 8.
- Move Choke to "Half" position. Figure 9.
- Grasp Top Handle and squeeze Throttle Trigger fully.
- Pull Starter Rope sharply until engine runs, but no more than 5 pulls. *Keep Throttle Trigger fully squeezed until engine runs smoothly.*

NOTE: If engine has not started, pull Starter Rope 5 more pulls. If engine still does not run, it is probably flooded. Wait a few minutes and repeat procedure with Choke at "Off" position. Figure 9.

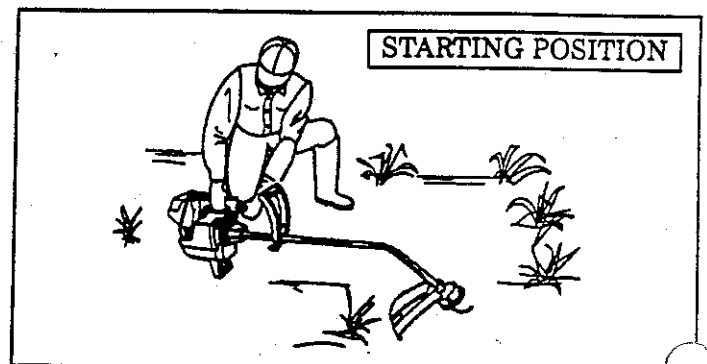

Figure 7

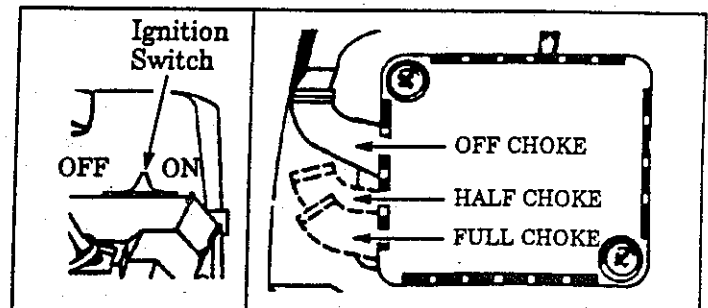

Figure 8

Figure 9

2. Always release the Throttle Trigger and allow the engine to return to idle speed when not cutting.

3. To stop engine:

- Release the Throttle Trigger.
- Move Ignition Switch to the "Off" position.

USING YOUR TRIMMER

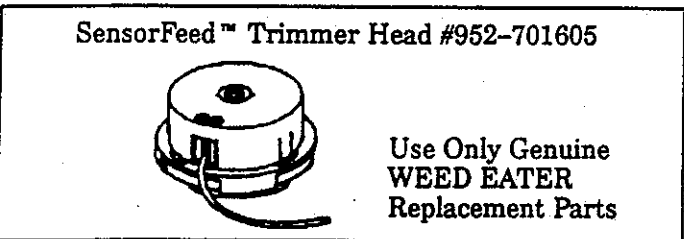
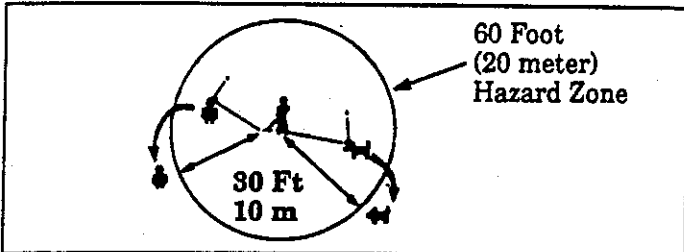
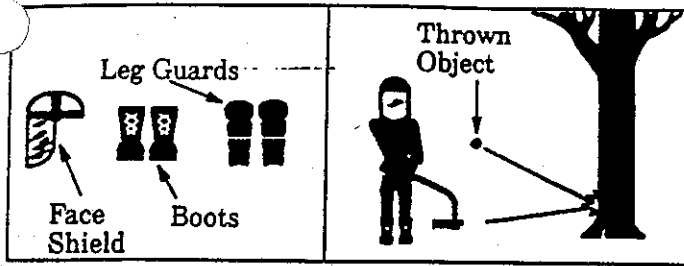

⚠ WARNING—THROWS OBJECTS

The rapidly moving line causes objects to be thrown violently. The shield will not provide complete protection to the operator or others. The operator must wear a safety face shield or goggles. Always wear heavy, long pants and boots. Keep others at least 30 feet (10 meters) away.

⚠ WARNING - HAZARD ZONE

This tool will throw objects and cut. Keep others including children, animals, bystanders and helpers at least 30 feet (10 meters) away from the operator and tool. Stop the engine if you are approached.

⚠ WARNING - DAMAGED TRIMMER HEAD

Trimmer head parts that are chipped, cracked or damaged in any other way can fly apart and cause serious injury. Do not use. Replace damaged parts before using the tool.

A. LINE TRIMMER SAFETY

1. OPERATOR

- Always wear a face safety shield or goggles. See "Accessories."
- Always wear heavy, long pants, boots, and gloves. See "Accessories." Do not wear loose clothing, jewelry, short pants, sandals or go barefoot. Secure hair so it is above shoulder length. Being fully covered will help protect you from pieces of toxic plants such as poison ivy thrown by the Trimmer Head which could be more of a hazard than touching the plant itself.
- Do not operate this tool when you are tired, ill or under the influence of alcohol, drugs or medication.
- Do not swing the tool with such force that you are in danger of losing your balance.
- Never start or run the engine inside a closed room or building. Breathing exhaust fumes can kill.
- Keep handles free of oil and fuel.

2. TOOL

- Inspect the entire tool before each use. Replace damaged parts. Check for fuel leaks and make sure all fasteners are in place and securely fastened.
- Use only .080" diameter WEED LINE® brand line. Never use wire, rope, string, etc.
- Be sure the shield is properly attached.
- Make sure the trimmer head is properly installed and securely fastened. Refer to "Assembly."

- Make carburetor adjustments with the drive shaft housing supported to prevent the trimmer line from contacting any object.
- Keep others away when making carburetor adjustments.
- Use only genuine Weed Eater accessories or attachments as recommended.

3. CUTTING

- Inspect the area to be cut before each use. Remove objects (rocks, broken glass, nails, wire, string, etc.) which can be thrown or become entangled in the trimmer head.
- Always keep the engine on the right-hand side of your body.
- Hold the tool firmly with both hands.
- Keep firm footing and balance. Do not over-reach.
- Keep the trimmer head below waist level.
- Do not raise the engine above your waist.
- Keep all parts of your body away from the trimmer line when the engine is running.
- Keep all parts of your body away from a hot muffler.
- Use only for jobs explained in this manual.

⚠ WARNING

Avoid any bodily contact with the muffler when starting a warm engine. A hot muffler can cause serious burns.

B. TRIMMER LINE ADVANCE

- The trimmer line advances automatically as the line wears and reduces the cutting path.
- The line will wear faster and will advance more frequently when cutting against hard surfaces such as rocks, bricks, concrete, metal fences, etc., than when cutting against woody objects such as trees or wooden fences.
- If line does not advance properly:
 - Operate the engine at full throttle and allow the line to strike a hard surface such as concrete or the ground.
 - If line is 4" or less, stop the engine and check for line binding or tangling on the spool. See "Trimmer Head" in the Maintenance Section for re-winding instructions.
- Always keep the shield in place when the tool is being operated. Figure 6.

▲ WARNING
Use only .080" diameter WEED LINE brand line. Other sizes of line will not advance properly. Do not use other materials such as wire, strip rope, etc. Wire can break off during cutting and become a dangerous missile that can cause serious injury.

▲ WARNING
Use minimum speed and do not crowd the line when cutting around hard objects (rock, gravel, fence posts, etc), which can damage the trimmer head, become entangled in the line, or be thrown causing a serious hazard.

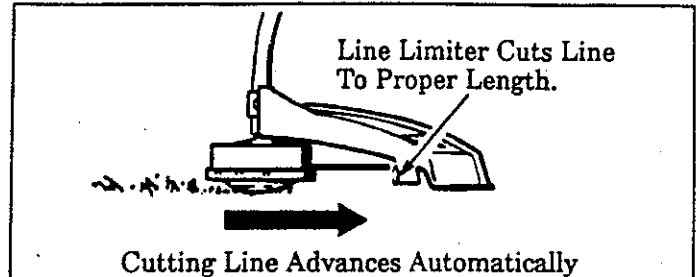

Figure 10

C. CUTTING METHODS

▲ WARNING
Use minimum speed and do not crowd the line when cutting around hard objects (rock, gravel, fence posts, etc), which can damage the trimmer head, become entangled in the line, or be thrown causing a serious hazard.

- The tip of the line does the cutting. You will achieve the best performance and minimum line wear by not crowding the line into the cutting area. The right and wrong way are shown in Figure 11.
- The line will easily remove grass and weeds from around walls, fences, trees and flower beds, but it also can cut the tender bark of trees or shrubs and scar fences. To help avoid damage especially to delicate vegetation or trees with tender bark, shorten line to 4-5 inches and use at less than full throttle.
- For trimming or scalping, use less than full throttle to increase line life and decrease head wear, especially:
 - during light duty cutting.
 - near objects around which the line can wrap such as small posts, trees or fence wire.
- For mowing or sweeping, use full throttle for a good clean job.

▲ WARNING
Always wear eye protection. Never lean over the trimmer head. Rocks or debris can ricochet or be thrown into eyes and face and cause blindness or other serious injury.

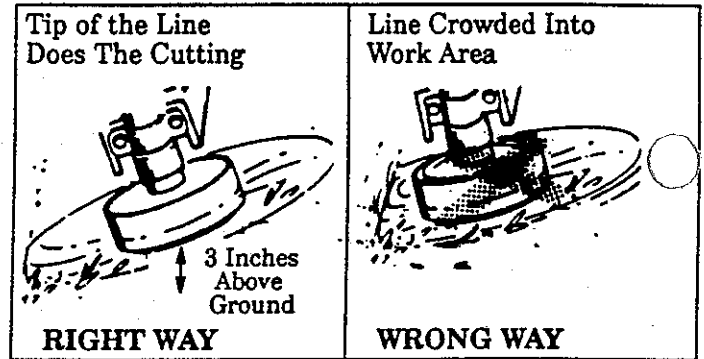

Figure 11

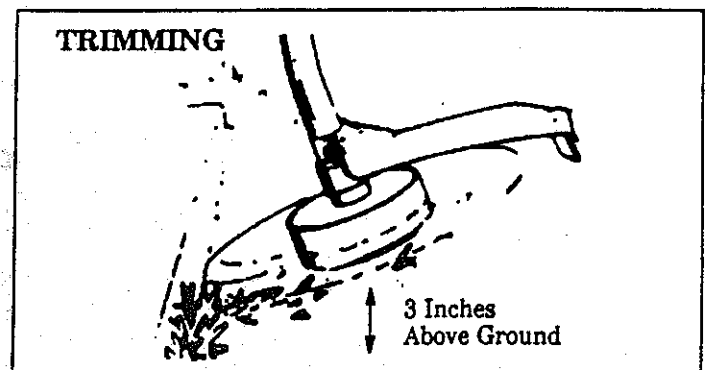

Figure 12

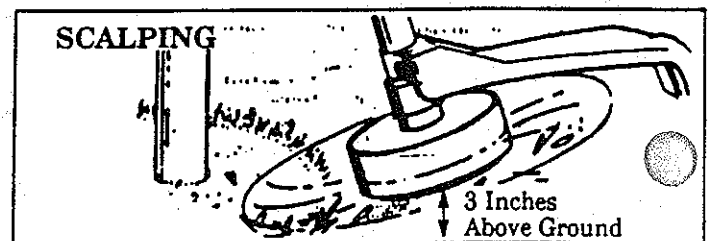

Figure 13

1. **TRIMMING** - Figure 12. Hold the bottom of the trimmer head about 3 inches above the ground and at an angle. Allow only the tip of the line to make contact. Do not force the trimmer line into the work area.
2. **SCALPING** - FIGURE 13. The scalping technique removes unwanted vegetation. Hold the bottom of the trimmer head about 3 inches above the ground and at an angle. Allow the tip of the line to strike the ground around trees, posts, monuments, etc. This technique increases line wear.

3. **MOWING** - Figure 14. Your trimmer is ideal for mowing in places conventional lawn mowers cannot reach. In the mowing position, keep the line parallel to the ground. Avoid pressing the head into the ground as this can scalp the ground and damage the tool.

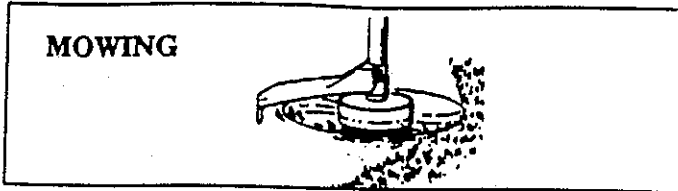

Figure 14

4. **SWEEPING** - Figure 15. The fanning action of the rotating line can be used for a quick and easy clean up. Keep the line parallel to and above the surfaces being swept and move the tool from side to side.

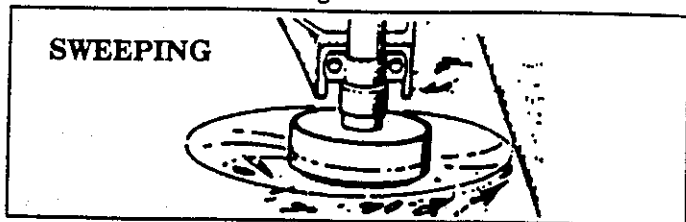

Figure 15

D. LINE REPLACEMENT

- **For proper line feed:**
 - Use only genuine Weed Eater pre-wound spools and .080" diameter WEED LINE brand line. Use of other types of spools or lines can result in excessive breakage, line welding and improper line feed.
 - Pre-wound spools offer the most convenient method for replacing line as well as optimum performance.
- Always clean dirt and debris from the spool and hub when performing any type maintenance.

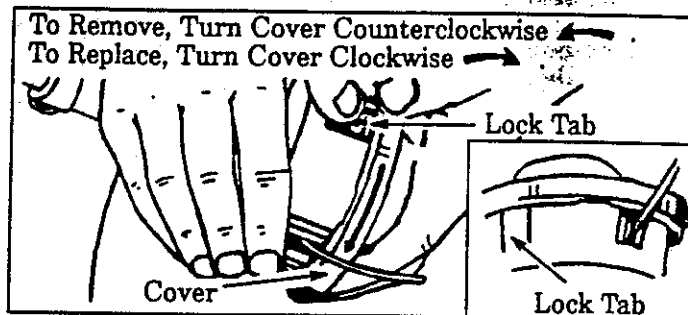

Figure 16

Installing Spool w/Line

- a. Hold the Trimmer Head as shown in Figure 16. Press the Lock Tab and turn Cover counterclockwise.
- b. Remove the Cover and Spool. Figure 16.
- c. Clean dirt and debris from all parts.
- d. Inspect all Trimmer head parts for damage. Replace damaged parts.

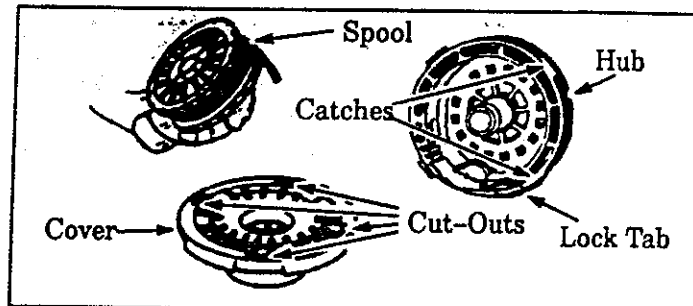

Figure 17

▲ WARNING
 Trimmer head parts that are chipped, cracked or damaged in any way can fly apart and cause serious injury. Do not use. Replace damaged parts before using the tool.

- e. Insert about 6 inches of Line from the inside of the Hub through the Line Exit Hole to the outside to keep the Line from backing into the Head. Figure 16.
- f. Route Line behind Balancing Pin (Figure 18) while carefully placing Spool in Hub.
- g. Pull on the Line extending outside the Hub to make sure the Line will not advance. See Inset, Figure 18. This indicates that the Line is routed properly.
- h. Reinstall Cover:
 - Align the four Catches on the Hub with the cutouts in the Cover. Figure 17.
 - Press the Cover onto the Hub.
 - Turn Cover clockwise. Figure 16.

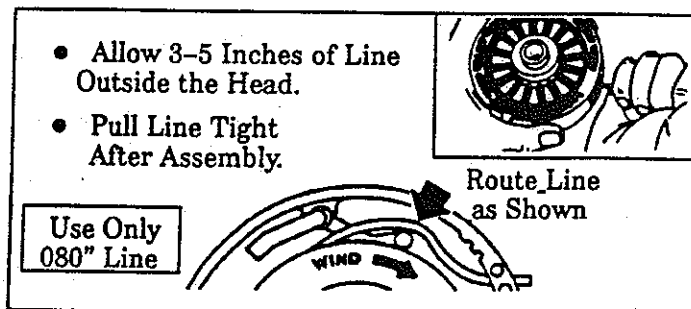

Figure 18

- i. Check to make sure all four Catches and the Lock Tab are properly fastened as shown in Figure 19, then test the Cover by trying to turn it counterclockwise.
- j. Pull on the Line again from outside the Hub. If the Line can be pulled from the assembled head, it is not properly routed around the Balancing Pin and will feed continuously when the Trimmer Head turns. Remove Cover and re-route Line as shown in Figure 18.

2. Installing Line on Spool

- Follow "Installing Spool w/Line," steps "a.-d."
- Remove any Line remaining on the Spool.
- Use a 40 foot length of .080" diameter WEED LINE® brand line.
- Insert 1/16" to 1/8" of the end of the Line through one of the holes in the rim of the Spool. Allow no more than 1/8" line to extend beyond the rim to avoid interference with line release action. Figure 20 .
- Wind the Line onto the Spool in the direction shown by the arrow on the Spool and as tightly and evenly as possible so the line will feed properly. Figure 20 .

CAUTION: The trimmer head will not function properly if the spool is filled beyond the notches around the outside edge of the spool.

- Follow "Installing Spool w/Line" steps "e.-j."

▲ WARNING

All four catches must be fastened and the lock tab latched onto the cover. If installed improperly, the cover can fly off and become a dangerous missile.

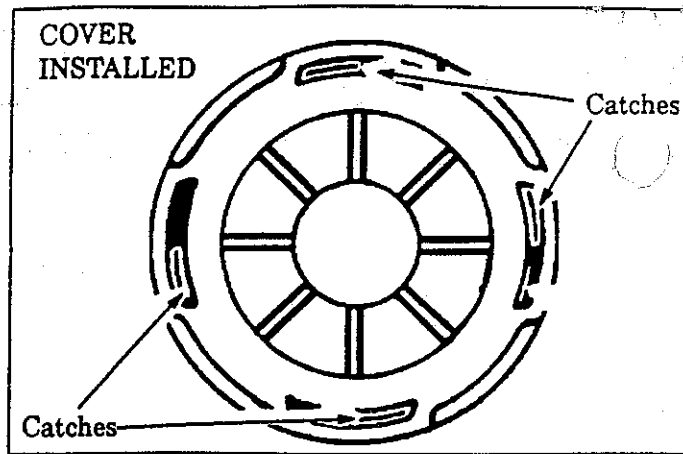

Figure 19

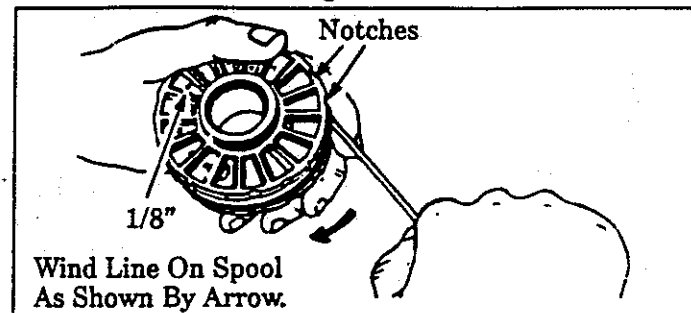

Figure 20

3. Trouble Shooting the Trimmer Line

- **Does not advance, or breaks while cutting:**
 - Improperly routed in head.
 - Improperly wound onto spool.
 - Line size incorrect.
 - Too little line outside head.
- **Pulls back into head:**
 - Too little line outside of head.
- **Welds onto spool:**
 - Line size incorrect.
 - Incorrect spool.
 - Crowding line against material being cut.
 - Cutting at higher speeds than necessary.
- **Releases continuously:**
 - Wound beyond notches on spool.
 - Improperly routed in head.
 - Line size incorrect.
- **Usage is excessive:**
 - Improperly routed in head.
 - Line size incorrect.
 - Cutting at high speeds around hard objects.
 - Crowding line against material being cut.
 - Incorrect spool.
 - Crowding line against material being cut.
 - Cutting at higher speeds than necessary.

NOTES

GENERAL MAINTENANCE

A. MAINTENANCE SAFETY

1. Maintain the tool according to recommended procedures. Keep the cutting line at the proper length.
2. Disconnect the spark plug before performing maintenance except for carburetor adjustments.
3. Make carburetor adjustments with the drive shaft housing supported to prevent the trimmer line from contacting any object.
4. Keep others away when making carburetor adjustments.

5. Replace trimmer head parts that are cracked, chipped or damaged before using the tool.
6. Use only .080" diameter WEED LINE brand line. Never use wire, rope, string, etc.
7. Use only genuine WEED EATER replacement parts as recommended.
8. Inspect the entire tool. Replace damaged parts. Check for fuel leaks and make sure all fasteners are in place and securely fastened.

B. STARTER ROPE

▲ WARNING

Do not remove the retaining tab and screw to remove pulley. The spring beneath the pulley is under tension and can fly out and cause serious injury. If any part of pulley housing assembly is damaged (other than the rope), do not use the tool. Take it to your Authorized Service Dealer.

1. Disconnect Spark Plug Wire. Figure 21 .
2. Loosen two "Nose Cone" Screws and remove Drive Shaft Housing from front shroud. Figure 21 .
3. Remove the six Front Shroud Screws with the small hex wrench provided. Figure 21 .
4. Remove the Top Handle Screw and Nut, and remove the Steel Spacer from the Rubber Bushing on the Handle Mount. Figure 21 .
5. Separate Front Shroud from Engine. Figure 21 .
6. Remove Retention Screw. Figure 22 . Untie Rope around the Pulley Ratchet and pull the Rope out of the Pulley Housing. Figure 22 .
7. Position the Pulley Housing as shown in Figure 22 . Hand turn the Pulley clockwise → as far as it will go. Then, turn the Pulley counterclockwise ← until the Pulley Notch is aligned with the Housing Notch. Figure 22 . Next, turn the Pulley one complete turn counterclockwise ← until the notches are aligned again.
8. Insert the small hex wrench into the hole formed by the Notches to hold the Pulley in position. Figure 22 (inset-upper right).
9. Use a 42" length of replacement Rope.
10. Move away 10 feet (3 meters) from the fuel tank with the replacement rope. Use a match and melt both ends of the Rope to prevent fraying.
11. Pull melted ends through a thick, clean rag while the Rope is still hot to obtain smooth, pointed ends.
12. Insert one end of the Rope through the Handle and secure with a knot. Leave a 3/16" pigtail behind the knot. Figure 22 (inset-upper left).
13. Insert the other end of the Rope through the Rope Exit Hole into the inside of the Housing, into the Pulley and up through the Pulley Hole. See Figure 22 (inset-upper right).
14. Wrap Rope counterclockwise ← around the Pulley Ratchet and tuck loose end under Rope at the Pulley Hole. Leave a 1 inch tail laying flat on top of the Pulley between the Retainer Rib and the Retention Post. Figure 22 .

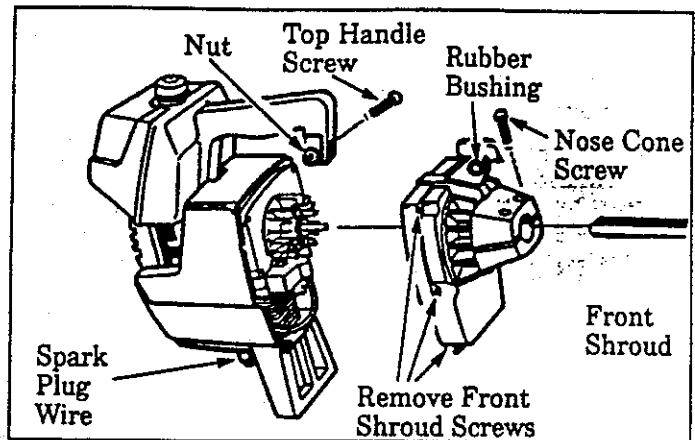

Figure 21

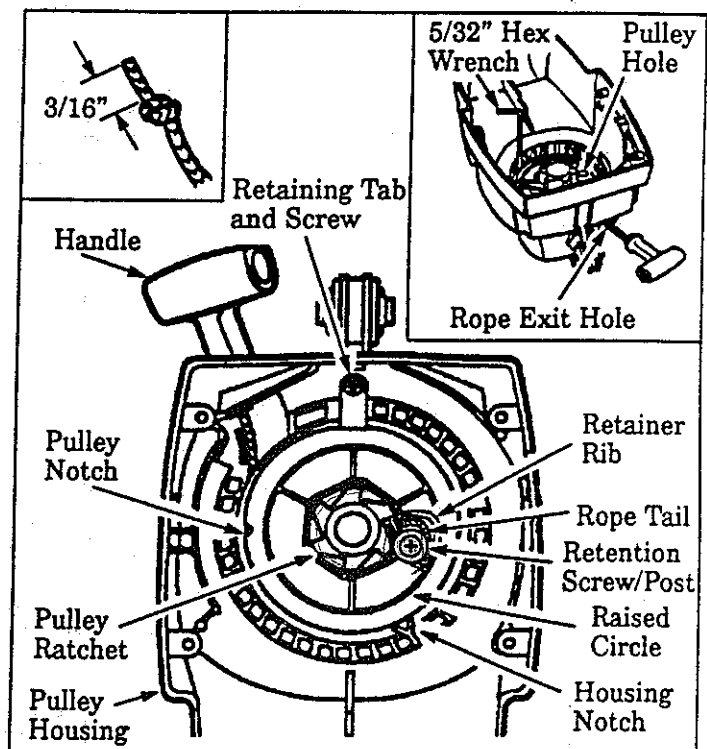

Figure 22

15. Re-install the Retention Screw. Pull firmly on the rope to tighten it against the Pulley Ratchet. The rope tail *must not* extend beyond the Raised Circle on the Pulley to prevent interference with the Retaining Tab. Figure 22 .
16. Hold Rope taut at Rope Exit Hole so it will not move and remove hex wrench.
17. Slowly feed rope into the Pulley Housing.
18. Reverse steps 1 through 4 to re-assemble.

C. CARBURETOR ADJUSTMENTS

NOTE: This is a complicated task. Read all warnings and instructions thoroughly before starting adjustments. If you do not think that you completely understand all warnings and instructions, let your service Dealer perform these adjustments.

▲ WARNING

Make carburetor adjustments with the drive shaft housing supported to prevent the trimmer line from contacting any object. Hold the tool with your hand; do not use the optional shoulder strap for support.

▲ WARNING

Keep others away when making carburetor adjustments.

▲ WARNING

Serious injury to the operator and others can occur if the carburetor is not properly adjusted.

- Poor engine performance can be a result of other causes such as dirty air filter, carbon build-up on muffler outlets, etc. See "Trouble Shooting Chart" before proceeding with carburetor adjustments.
- The carburetor has been carefully adjusted at the factory. However, the operator must be sure that adjustments are made when any of the conditions occur as mentioned in "Trouble Shooting Suggestions".
- Very small adjustments can affect engine performance. It is important to turn the screw a very small amount per adjustment and test performance before making further adjustments. Each adjustment should be no more than the width of the slot in the adjusting screw.
- This is a complicated task and it is important to follow instructions in sequence as indicated.

1. TROUBLE SHOOTING SUGGESTIONS

- Engine will not continue to run at idle position. See "Idle Speed Adjustment" and "Mixture Adjustment."
- Engine dies or hesitates when it should accelerate. See "Acceleration Check."
- Loss of cutting power which cannot be corrected by cleaning the air filter. See "Mixture Adjustment."
- Engine does not return to idle from full throttle within 2 seconds. See "Deceleration Check."
- Engine will not run. See "Trouble Shooting Chart." Then, if the carburetor requires adjustment, begin with "Basic Carburetor Settings."

▲ WARNING

The trimmer head will be spinning during this procedure. Wear your protective equipment and observe all safety instructions.

2. BASIC CARBURETOR SETTINGS

NOTE: In most cases, your engine can be made to run properly with minor carburetor adjustments. Refer to "Trouble Shooting Suggestions" in the left column for the condition you are experiencing and follow the instructions. The basic carburetor settings are provided below.

- a. Turn the Mixture Screw (Figure 23) clockwise until it stops. *Do not turn the screw until it is tight as damage to the needle seat can occur.*
- b. Turn the Mixture Screw between three-quarters and one full turn counterclockwise ←.

3. ADJUSTING PROCEDURE

a. PREPARATION

1. Use a fresh fuel mix. See "Fueling Your Engine."
2. Make sure the line extends to the length allowed by the line limiter to provide correct load on engine.
3. Start the engine. Cut grass for 3 minutes to warm engine. *The engine must be at operating temperature before carburetor adjustments can be performed correctly.*

b. IDLE SPEED ADJUSTMENT

1. Allow engine to idle.
2. Adjust Idle Speed Screw (Figure 35) until the engine continues to run without stalling.
 - Turn screw clockwise → to increase engine speed if the engine stalls or dies.
 - Turn screw counterclockwise ← to slow engine down.
3. Follow instructions in "Acceleration Check" and "Deceleration Check."
4. No further adjustments are necessary if performance is satisfactory.

c. ACCELERATION CHECK

1. Allow engine to idle.
2. Squeeze Trigger fully
 - a. If performance is satisfactory, proceed to "d. Deceleration Check."
 - b. If the engine does not accelerate smoothly, turn the Mixture Screw (Figure 23) counterclockwise ← a small amount (no more than the width of the slot in the adjusting screw).
3. Repeat step "2." until smooth acceleration is obtained.

NOTE: It may be necessary to repeat "Idle Speed Adjustment" through "Acceleration Check," to obtain correct adjustments.

4. Follow instructions in "Deceleration Check."

d. DECELERATION CHECK

1. Allow engine to idle, then squeeze Throttle Trigger fully.
2. Allow engine to run at full speed for about 1 second.
3. Release the Throttle Trigger to the idle position and listen to the deceleration of the engine. It must return to idle smoothly and within 1 to 2 seconds.
 - a. If performance is satisfactory, no further adjustments are necessary.
 - b. If the engine slowly or erratically returns to idle or idles erratically, proceed to "Mixture Adjustment."

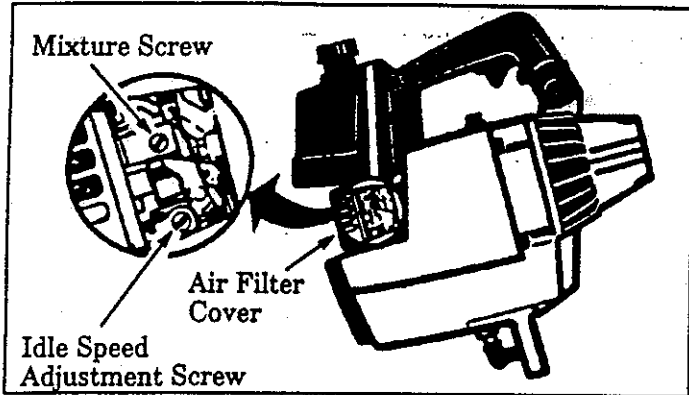

Figure 23

e. MIXTURE ADJUSTMENT

CAUTION: Do not operate engine at full throttle for prolonged periods while making mixture adjustments as damage to the engine can occur.

1. Support the drive shaft housing so the trimmer head is off the ground and the line will not make contact with any object.
2. Start the engine. Allow engine to idle, then squeeze Throttle Trigger fully.

NOTE: Perform steps "3." through "5." at full throttle.

3. Turn Mixture Screw (Figure 23) very slowly clockwise \rightarrow until engine speed is reduced.
4. Turn Mixture Screw very slowly counter-clockwise \leftarrow . Stop when the engine begins to run roughly.
5. Turn the screw slowly the minimum amount clockwise \rightarrow until the engine runs smoothly.
6. Follow instructions in "Acceleration Check" and "Deceleration Check".

CAUTION: If the engine does not operate according to these instructions after repeating the adjusting steps, do not use the tool. Take it to your Authorized Service Dealer.

D. AIR FILTER

NOTE: A dirty air filter decreases the life and performance of the engine and increases fuel consumption.

1. Clean the Air Filter:

- Use Air Filter #952-701614.
- Always after 5 tanks of fuel or 5 hours of operation, whichever is less.
- More frequently, in dusty conditions.
 - a. Loosen the two Screws on the Air Filter Cover enough to remove the Cover from the Engine. Figure 24.
 - b. Remove the Air Filter from the Cover. Figure 24.
 - c. Wash Filter in soap and water.
 - d. Squeeze Filter dry and replace in Cover.

CAUTION: Do not clean the air filter in gasoline or other flammable solvent to avoid creating a fire hazard.

- e. Reinstall the Air Filter Cover, making sure the Choke Exit Slot (Figure 24) is placed over the Choke Lever.

CAUTION: Make sure the air filter is fitted into the corners of the cover to keep dust from entering the engine and causing engine damage.

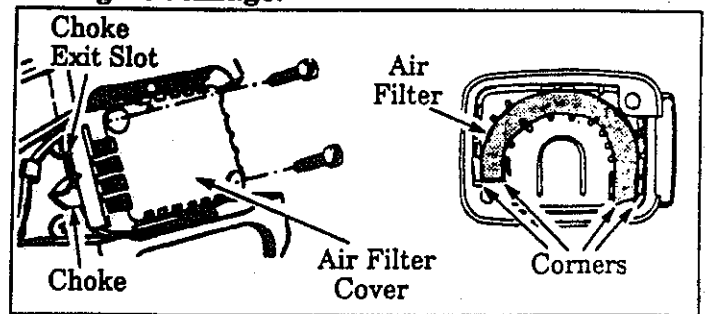

Figure 24

NOTES

E. DRIVE SHAFT LUBRICATION

- Lubricate the Drive Shaft:
 - After each ten (10) hours of operation.
 - Before operating if the tool has been stored for 90 days or longer.
- Use the following procedure for best results:
 - Use Flex shaft Lube #952-701570.

▲ WARNING

If engine has just been operated, avoid touching the muffler. A hot muffler can cause serious burns.

CAUTION: Lay the drive shaft on a clean surface. Avoid laying the shaft on the floor, ground or on any other surface that may have dirt or debris. Even after wiping the shaft, grease residue can pick up dirt particles that can cause damage or premature failure.

CAUTION: Take care to avoid injuring your hands and fingers with broken wires when checking for damage or wiping the shaft. A cloth will not prevent broken wires from puncturing or tearing your skin.

1. Loosen the "Nose Cone" screws and remove the Drive Shaft Housing from the Engine.
2. Remove the Drive Shaft from the drive Shaft Housing. Figure 25 .
3. Check the Drive Shaft for broken wires, kinks, or kinks, and replace if damage is found.
4. Using a clean cloth, wipe the surface of the Drive Shaft thoroughly to remove any old grease.
5. Apply a uniform coat of lube to the entire surface of the Drive Shaft.
6. Inject the remaining contents of the tube into the top of the Drive Shaft Housing.
7. Replace Drive Shaft in the Drive Shaft Housing. Tighten Screws securely.
8. Reassemble the Drive Shaft Housing and the Engine.

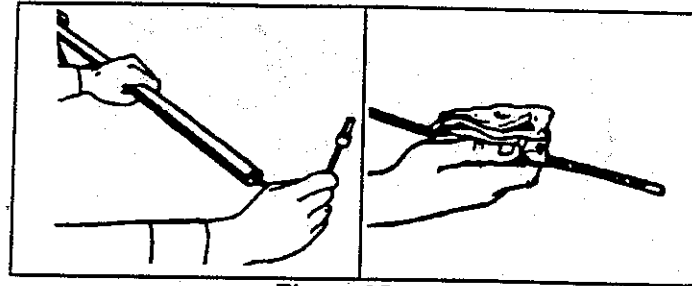

Figure 25

NOTES

F.TROUBLE SHOOTING CHART

SYMPTOM	CAUSE	REMEDY
Engine will not start or will run only for a few seconds after starting.	<ol style="list-style-type: none"> 1. Fuel tank empty. 2. Engine flooded. 3. Spark plug not firing. 4. Fuel not reaching carburetor. 5. Carburetor requires adjustment. 6. None of the above. 	<ol style="list-style-type: none"> 1. Fill tank with correct fuel mixture 2. See "Starting Instructions." 3. Install new plug/check ignition system. 4. Clean fuel filter; inspect fuel line. 5. See "Carburetor Adjustments" 6. Contact your Authorized Service Dealer.
Engine will not idle properly.	<ol style="list-style-type: none"> 1. Idle speed set too fast or too slow. 2. Fuel mixture requires adjustment. 3. None of the above. 	<ol style="list-style-type: none"> 1. See "Carburetor Adjustments." 2. See "Carburetor Adjustments." 3. Contact your Authorized Service Dealer
Engine will not accelerate, lacks power, or dies under a load.	<ol style="list-style-type: none"> 1. Air filter dirty. 2. Spark plug fouled. 3. Carburetor requires adjustment. 4. Muffler outlets plugged. 5. None of the above. 	<ol style="list-style-type: none"> 1. Clean or replace air filter. 2. Clean or replace spark plug and re-gap. 3. See "Carburetor Adjustments." 4. Contact your Authorized Service Dealer 5. Contact your Authorized Service Dealer.
Engine smokes excessively.	<ol style="list-style-type: none"> 1. Air filter dirty. 2. Fuel mixture incorrect. 3. Fuel mixture requires adjustment. 	<ol style="list-style-type: none"> 1. Clean or replace air filter. 2. See "Fueling Your Unit." 3. See "Carburetor Adjustments."
Engine runs hot.	<ol style="list-style-type: none"> 1. Fuel mixture incorrect. 2. Fuel mixture set too low (lean). 3. Spark plug incorrect. 4. None of the above. 	<ol style="list-style-type: none"> 1. See "Fueling Your Unit." 2. See "Carburetor Adjustments." 3. Replace with correct plug. 4. Contact your Authorized Service Dealer.
Cutting Head stops under a load or does not turn when engine is accelerated.	<ol style="list-style-type: none"> 1. Drive shaft broken or not engaged. 	<ol style="list-style-type: none"> 1. Replace or see "Assembly".
Line does not advance or breaks while cutting.	<ol style="list-style-type: none"> 1. Line improperly routed in head. 2. Line improperly wound onto spool. 3. Line size incorrect. 4. Too little line outside head. 5. Dirt accumulated on cover cut-outs. 	<ol style="list-style-type: none"> 1. Remove cover. Check line routing. 2. Rewind line tightly and evenly. 3. Use only .080" WEED LINE Brand Line. 4. Remove cover. Pull 4" of line to outside. 5. Clean cover cut-outs.
Line welds on spool.	<ol style="list-style-type: none"> 1. Line size incorrect. 2. Crowding line against material being cut. 4. Cutting at higher speed than necessary. 	<ol style="list-style-type: none"> 1. Use only .080" WEED LINE Brand Line. 2. Cut with tip of line. 4. Reduce cutting speed.
Line releases continuously.	<ol style="list-style-type: none"> 1. Line improperly routed in head. 2. Balance arm broken. 3. Line size incorrect. 	<ol style="list-style-type: none"> 1. Remove cover. Check line routing. 2. Replace head. 3. Use only .080" WEED LINE Brand Line.
Line usage is excessive.	<ol style="list-style-type: none"> 1. Line size incorrect. 2. Cutting at high speed around hard objects. 3. Crowding line against material being cut. 	<ol style="list-style-type: none"> 1. Use only .080" WEED LINE Brand Line. 2. Reduce speed around hard objects. 3. Cut with tip of line.
Line pulls back into head.	<ol style="list-style-type: none"> 1. Too little line outside of head. 	<ol style="list-style-type: none"> 1. Remove cover. Pull 4" of line to outside.